

CHENZHU 辰竹

CZSR Classic 系列安全继电器 支持各类安全信号输入

2nd Edition

SIL3 PLe Cat.4 | TÜV 莱茵认证

G3 防腐 | 5 年质保



【辰竹官方网站】



公司简介

COMPANY PROFILE

▶ 辰竹 专注专业

CHENZHU FOCUSED ON PROFESSIONALISM

上海辰竹仪表有限公司成立于2002年4月，由原上海工业自动化仪表研究所九五攻关项目组转制而来，现专业从事工业自动化“安全仪表技术”的研究/咨询，产品开发/制造/销售/服务，主营安全栅、隔离器、电涌保护器、安全继电器、智能I/O等产品。



仪器仪表行业两化融合标杆企业

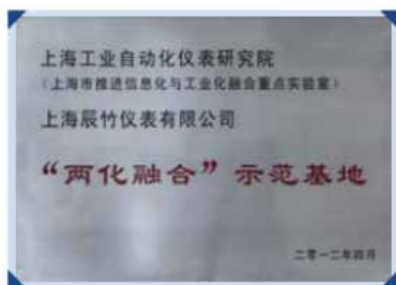

- 上海市高新技术企业
- 上海市科技小巨人(培育)企业
- 上海市五一劳动奖状获得者
- 上海市先进私营企业
- 上海市仪器仪表行业经济运行十佳企业

- 华东理工大学工程硕士联合培养基地
- 上海应用技术大学联合培养工作室

- 中国仪器仪表行业协会理事单位
- 中国石油和化工自动化应用协会理事单位
- 上海仪器仪表行业协会理事单位

- 仪器仪表行业两化深度融合标杆企业

- 上海市专利工作试点企业
- 上海市松江区企业技术中心

管理体系

MANAGEMENT SYSTEMS



ISO9001 质量管理



ISO14001 环境管理



ISO45001 健康安全管理



安全生产标准化三级



两化融合管理体系

研发 发展源泉

R&D SOURCE OF DEVELOPMENT

建立以ISO/IEC/GB等国内外标准为规范、围绕安全保护电子产品的全面专业测试体系,配备完善的测试设备,能够满足国内外标准70多个项目的测试和检验,全面支持研究开发的试验过程。



■ 辰竹实验室符合ISO/IEC 17025体系要求,并取得德国莱茵TÜV集团颁发的体系认可证书。



R&D Team

28%

研发团队占比
员工总数



R&D Investment

12%

年销售收入
投入研发



Innovation

110+

核心知识产权



Testing Facility

70+

测试能力

品质 成就未来

QUALITY ACHIEVEMENTS IN THE FUTURE

辰竹工厂持续以精益管理+智能制造双线驱动,以品质管理系统作为生产的保证,确保生产出符合设计规范且满足客户要求的产品品质。



Factory

2500m²

生产面积



Max Cap.

1,000,000台

最大年产量



Lean Production

10+年

精益生产



SIL3
IEC61508

PLe Cat.4



— CZSR Classic系列安全继电器产品特点

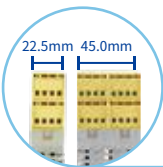

两种通用外壳

22.5mm与45mm两种外壳机型，外观尺寸通用性强



电路板三防漆涂覆

保护电路板防潮、绝缘、防水、防尘、防零件松脱



接线方便

电源、输入端、输出端分别用红黑色，黄色和白色进行区分



方便插拔

可插拔端子台，使得接线更简单

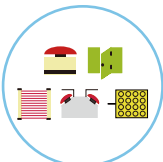

支持多种设备输入

急停按钮 | 安全门
安全光幕 | 双手按钮
安全地毯



快速查询

通过扫描产品铭牌上的二维码，可以快捷地查询到产品资料

CZSR Classic 产品选型一览表 Product List

输入设备 Input Devices	型号 Model	电源 Power	复位方式 Reset Mode	继电器输出 Relay Output				晶体管输出 Transistor output	页码 Page
				安全断开		安全闭合			
	CZSR8001-3A1B	24V DC/AC	自动 / 手动	3	-	1	-	-	5
	CZSR8001-3A1B(M)	24V DC/AC	受监控的手动	2	-	2	-	-	5
	CZSR8002-2A2AT	24V DC	自动 / 手动	2	2	-	-	-	6
	CZSR8002-2A2AT(M)	24V DC	受监控的手动	2	2	-	-	-	6
	CZSR8003-3A1B	230V AC	自动 / 手动	3	-	1	-	-	7
	New CZSR8001-2A1B	24V DC/AC	自动 / 手动	2	-	1	-	-	8
	New CZSR8001-2A1B3AT1BT	24V DC/AC	自动 / 手动	2	3	1	1	-	8
	CZSR8001-3A1B-P	24V DC	自动 / 手动	3	-	1	-	-	9
	CZSR8101-3A1B-N	24V DC	自动 / 手动	3	-	1	-	-	9
	CZSR8201-3A1B	24V DC/AC	无复位	3	-	1	-	-	10
	CZSR8301-3A1B	24V DC/AC	自动 / 手动	3	-	1	-	-	11
	CZSR8301-3A1B(M)	24V DC/AC	受监控的手动	3	-	1	-	-	11
	CZSR8302-3A1B	24V DC/AC	通用复位	3	-	1	-	-	12
	CZSR8303-3A1B	230V AC	通用复位	3	-	1	-	-	12
	New CZSR8302-2A1B1S	24V DC/AC	自动 / 手动	2	-	1	-	1	13
	New CZSR8302-2AT1BT1S	24V DC/AC	自动 / 手动	-	2	-	1	1	13
	CZSR8801-4A2B	24V DC	自动 / 手动	4	-	1	-	-	14
	CZSR8801-8A4B	24V DC	自动 / 手动	8	-	2	-	-	14

急停按钮，安全门输入 E-Stop Buttons, Safety Gates Input

产品特征 Features

支持单、双通道操作 Single or dual channel
 支持自动复位和手动复位 Manual or automatic reset
 通道间短路监控 Short circuit monitoring

CZSR8001-3A1B

CZSR8001-3A1B(M)

电源特性	Power data		
供电电压	Supply voltage	24V DC/AC	24V DC/AC
电压容差	Voltage tolerance	0.85~1.1	0.85~1.1
电流损耗	Current consumption	≤90mA (24V DC) / ≤240mA (24V AC)	≤90mA (24V DC) / ≤240mA (24V AC)
输入特性	Input data		
输入电流	Input current	≤50mA (24V DC)	≤50mA (24V DC)
导线电阻	Cable resistance	≤15Ω	≤15Ω
输入设备	Input devices	E-stop buttons, Safety gates	E-stop buttons, Safety gates
输出特性	Output data		
触点数量	Number of contacts	3NO+1NC	3NO+1NC
触点材料	Contact material	AgSnO ₂ + 0.2 μm Au	AgSnO ₂ + 0.2 μm Au
触点熔丝保护	External contact fuse protection	10A gL/gG NEOZED (NO); 6A gL/gG NEOZED (NC)	10A gL/gG NEOZED (NO); 6A gL/gG NEOZED (NC)
触点机械寿命	Mechanical endurance of contacts	10 ⁷ 次以上	10 ⁷ 次以上
切换容量	Utilisation category	In accordance with EN60947-5-1: AC-15, 5A/230V; DC-13, 5A/24V	In accordance with EN60947-5-1: AC-15, 5A/230V; DC-13, 5A/24V
时间特性	Time data		
吸合缓冲时间	Switch-on delay	≤300ms	≤150ms
释放缓冲时间	Delay-on de-energisation	≤30ms	≤30ms
恢复时间	Recovery time	≤100ms	≤100ms
电源短时中断	Supply short interruption	20ms	20ms
环境特性	Environmental data		
电磁兼容	EMC	EN60947, EN61000-6-2, EN61000-6-4	EN60947, EN61000-6-2, EN61000-6-4
振动	Vibration	Vibration frequency: 10Hz~55Hz; Vibration amplitude: 0.35mm	Vibration frequency: 10Hz~55Hz; Vibration amplitude: 0.35mm
使用温度	Ambient temperature	-20°C~+60°C	-20°C~+60°C
储存温度	Storage temperature	-40°C~+85°C	-40°C~+85°C
相对湿度	Relative humidity	10%~90%	10%~90%
海拔高度	Elevation	≤2000m	≤2000m
绝缘特性	Insulation data		
过压等级	Overvoltage category	III	III
污染等级	Pollution degree	2	2
额定绝缘电压	Rated insulation voltage	250V AC	250V AC
额定冲击电压	Rated impulse voltage	6000V (1.2/50us)	6000V (1.2/50us)
绝缘强度	Dielectric strength	1500V AC, 1min	1500V AC, 1min
电气间隙和爬电距离	Clearance and creepage distance	In accordance with EN 60947-1	In accordance with EN 60947-1
认证	Certification		
安全完整性等级	Safety integrity level	SIL3	SIL3
性能等级	Performance level	PLe	PLe
安全类别	Category	Cat.4	Cat.4

外观图 Products show

114.5mm×99.0mm×22.5mm



功能框图 Block diagram

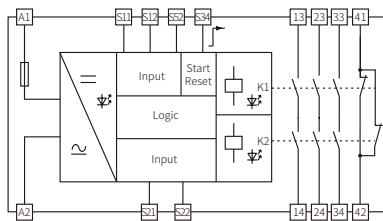

CZSR8001-3A1B

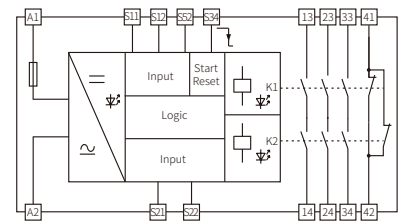

CZSR8001-3A1B(M)



急停按钮，安全门输入 E-Stop Buttons, Safety Gates Input

产品特征 Features

支持延时/非延时输出 Instantaneous or delayed output

支持自动复位和手动复位 Manual or automatic reset

通道间短路监控 Short circuit monitoring

CZSR8002-2A2AT

CZSR8002-2A2AT(M)

电源特性	Power data	
供电电压	Supply voltage	24V DC
电压容差	Voltage tolerance	0.85~1.1
电流损耗	Current consumption	≤130mA (24V DC)
输入特性	Input data	
输入电流	Input current	≤50mA (24V DC)
导线电阻	Cable resistance	≤15Ω
输入设备	Input devices	E-stop buttons, Safety gates
输出特性	Output data	
触点数量	Number of contacts	2NO+2NO(t)
触点材料	Contact material	AgSnO ₂
触点熔丝保护	External contact fuse protection	10A gL/gG NEOZED (NO)
触点机械寿命	Mechanical endurance of contacts	10 ⁷ 次以上
切换容量	Utilisation category	In accordance with EN60947-5-1: AC-15, 3A/230V; DC-13, 3A/24V
时间特性	Time data	
吸合缓冲时间	Switch-on delay	≤300ms
释放缓冲时间	Delay-on de-energisation	≤30ms (instantaneous); 0.1s~3s (delayed, factory set as 3s)
恢复时间	Recovery time	≤100ms
电源短时中断	Supply short interruption	20ms
环境特性	Environmental data	
电磁兼容	EMC	EN60947, EN61000-6-2, EN61000-6-4
振动	Vibration	Vibration frequency: 10Hz~55Hz; Vibration amplitude: 0.35mm
使用温度	Ambient temperature	-20°C~+60°C
储存温度	Storage temperature	-40°C~+85°C
相对湿度	Relative humidity	10%~90%
海拔高度	Elevation	≤2000m
绝缘特性	Insulation data	
过压等级	Overvoltage category	III
污染等级	Pollution degree	2
额定绝缘电压	Rated insulation voltage	250V AC
额定冲击电压	Rated impulse voltage	6000V (1.2/50us)
绝缘强度	Dielectric strength	1500V AC, 1min
电气间隙和爬电距离	Clearance and creepage distance	In accordance with EN 60947-1
认证	Certification	
安全完整性等级	Safety integrity level	SIL3
性能等级	Performance level	PLe
安全类别	Category	Cat.4

外观图 Products show

114.5mm×99.0mm×22.5mm



功能框图 Block diagram

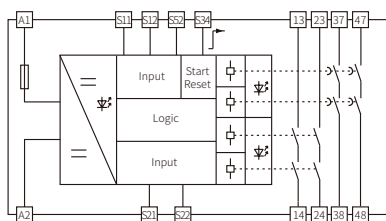

CZSR8002-2A2AT

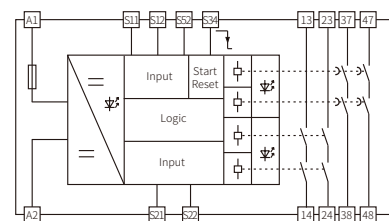

CZSR8002-2A2AT(M)

急停按钮，安全门输入 E-Stop Buttons, Safety Gates Input

产品特征 Features

支持单、双通道输入 Single or dual channel
 支持自动复位和手动复位 Manual or automatic reset
 通道间短路监控 Short circuit monitoring

CZSR8003-3A1B

电源特性	Power data	
供电电压	Supply voltage	100V~230V AC
电流损耗	Current consumption	≤7 VA (220V AC)
输入特性	Input data	
输入电流	Input current	≤50mA (220V AC)
导线电阻	Cable resistance	≤15Ω
输入设备	Input devices	E-stop buttons, Safety gates
输出特性	Output data	
触点数量	Number of contacts	3NO+1NC
触点材料	Contact material	AgSnO ₂ + 0.2 μm Au
触点熔丝保护	External contact fuse protection	10A gL/gG NEOZED (NO); 6A gL/gG NEOZED (NC)
触点机械寿命	Mechanical endurance of contacts	10 ⁷ 次以上
切换容量	Utilisation category	In accordance with EN60947-5-1: AC-15, 5A/230V; DC-13, 5A/24V
时间特性	Time data	
吸合缓冲时间	Switch-on delay	≤300ms
释放缓冲时间	Delay-on de-energisation	≤30ms
恢复时间	Recovery time	≤500ms
电源短时中断	Supply short interruption	20ms
环境特性	Environmental data	
电磁兼容	EMC	EN60947, EN61000-6-2, EN61000-6-4
振动	Vibration	Vibration frequency: 10Hz~55Hz; Vibration amplitude: 0.35mm
使用温度	Ambient temperature	-20°C~+60°C
储存温度	Storage temperature	-40°C~+85°C
相对湿度	Relative humidity	10%~90%
海拔高度	Elevation	≤2000m
绝缘特性	Insulation data	
过压等级	Overvoltage category	II
污染等级	Pollution degree	2
额定绝缘电压	Rated insulation voltage	250V AC
额定冲击电压	Rated impulse voltage	6000V (1.2/50us)
绝缘强度	Dielectric strength	1500V AC, 1min
电气间隙和爬电距离	Clearance and creepage distance	In accordance with EN 60947-1
认证	Certification	
安全完整性等级	Safety integrity level	SIL3
性能等级	Performance level	PLe
安全类别	Category	Cat.4

外观图 Products show

114.5mm×99.0mm×22.5mm



功能框图 Block diagram

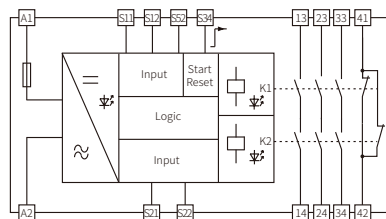

CZSR8003-3A1B



急停按钮，安全门输入 E-Stop Buttons, Safety Gates Input

Newly Released

产品特征 Features

支持单、双通道输入 Single or dual channel
支持自动复位和手动复位 Manual or automatic reset
通道间短路监控 Short circuit monitoring

CZSR8001-2A1B

CZSR8001-2A1B3AT1BT

电源特性	Power data		
供电电压	Supply voltage	24V DC/AC	24V DC/AC
电压容差	Voltage tolerance	0.85~1.1	0.85~1.1
电流损耗	Current consumption	≤90mA (24V DC) / ≤240mA (24V DC)	≤170mA (24V DC) / ≤400mA (24V AC)
输入特性	Input data		
输入电流	Input current	≤50mA (24V DC)	≤50mA (24V DC)
导线电阻	Cable resistance	≤15Ω	≤15Ω
输入设备	Input devices	E-stop buttons, Safety gates	E-stop buttons, Safety gates
继电器输出特性	Output data		
触点数量	Number of contacts	2NO+2NC	2NO+1NC+3NO(t)+1NC(t)
触点材料	Contact material	AgSnO ₂ + 0.2 μm Au	AgSnO ₂ + 0.2 μm Au
触点熔丝保护	External contact fuse protection	10A gL/gG NEOZED (N/O); 6A gL/gG NEOZED (N/C)	10A gL/gG NEOZED (N/O); 6A gL/gG NEOZED (N/C)
触点机械寿命	Mechanical endurance of contacts	10 ⁷ 次以上	10 ⁷ 次以上
切换容量	Utilisation category	In accordance with EN60947-5-1: AC-15, 5A/230V; DC-13, 5A/24V	In accordance with EN60947-5-1: AC-15, 5A/230V; DC-13, 5A/24V
时间特性	Time data		
吸合缓冲时间	Switch-on delay	≤300ms	≤300ms
释放缓冲时间	Delay-on de-energisation	≤30ms (instantaneous); -	≤30ms (instantaneous) 0s, 0.5s, 1s, 2s, 3s, 5s(delayed, factory set as 5s)
恢复时间	Recovery time	≤100ms	≤100ms
电源短时中断	Supply short interruption	20ms	20ms
环境特性	Environmental data		
电磁兼容	EMC	EN60947, EN61000-6-2, EN61000-6-4	EN60947, EN61000-6-2, EN61000-6-4
振动	Vibration	Vibration frequency: 10Hz~55Hz; Vibration amplitude: 0.35mm	Vibration frequency: 10Hz~55Hz; Vibration amplitude: 0.35mm
使用温度	Ambient temperature	-20°C~+60°C	-20°C~+60°C
储存温度	Storage temperature	-40°C~+85°C	-40°C~+85°C
相对湿度	Relative humidity	10%~90%	10%~90%
海拔高度	Elevation	≤2000m	≤2000m
绝缘特性	Insulation data		
过压等级	Overvoltage category	II	II
污染等级	Pollution degree	2	2
额定绝缘电压	Rated insulation voltage	250V AC	250V AC
额定冲击电压	Rated impulse voltage	4000V (1.2/50us)	4000V (1.2/50us)
绝缘强度	Dielectric strength	1500V AC, 1min	1500V AC, 1min
电气间隙和爬电距离	Clearance and creepage distance	In accordance with EN 60947-1	In accordance with EN 60947-1
认证	Certification		
安全完整性等级	Safety integrity level	SIL3	SIL3
性能等级	Performance level	PLe	PLe
安全类别	Category	Cat.4	Cat.4

外观图 Products show

114.5mm×99.0mm×22.5mm (CZSR8001-2A1B)
114.5mm×99.0mm×45mm (CZSR8001-2A1B3AT1BT)



SIL3
IEC61508

PLe
Cat.4
EN18013849

功能框图 Block diagram

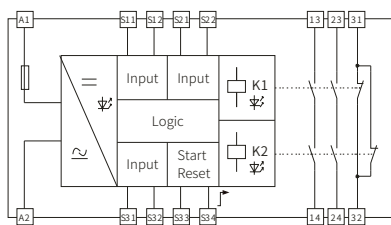

CZSR8001-2A1B

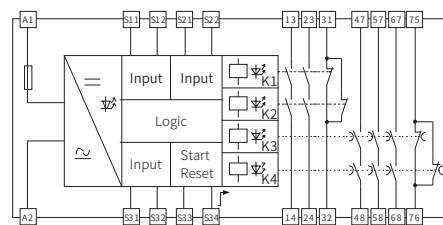

CZSR8001-2A1B3AT1BT

安全光幕输入 Light Beam Devices Input

产品特征 Features

支持PNP型安全光幕 PNP type light beam devices

支持双通道输入 Dual channel

支持自动复位和手动复位 Manual or automatic reset

CZSR8001-3A1B-P

CZSR8101-3A1B-N

电源特性	Power data		
供电电压	Supply voltage	24V DC	24V DC
电压容差	Voltage tolerance	0.85~1.1	0.85~1.1
电流损耗	Current consumption	≤90mA (24V DC)	≤90mA (24V DC)
输入特性	Input data		
输入电流	Input current	≤50mA (24V DC)	≤50mA (24V DC)
导线电阻	Cable resistance	≤15Ω	≤15Ω
输入设备	Input devices	PNP type light beam devices	NPN type light beam devices
输出特性	Output data		
触点数量	Number of contacts	3NO+1NC	3NO+1NC
触点材料	Contact material	AgSnO ₂ + 0.2 μm Au	AgSnO ₂ + 0.2 μm Au
触点熔丝保护	External contact fuse protection	10A gL/gG NEOZED (NO) ; 6A gL/gG NEOZED (NC)	10A gL/gG NEOZED (NO); 6A gL/gG NEOZED (NC)
触点机械寿命	Mechanical endurance of contacts	10 ⁷ 次以上	10 ⁷ 次以上
切换容量	Utilisation category	In accordance with EN60947-5-1: AC-15, 5A/230V; DC-13, 5A/24V	In accordance with EN60947-5-1: AC-15, 5A/230V; DC-13, 5A/24V
时间特性	Time data		
吸合缓冲时间	Switch-on delay	≤300ms	≤300ms
释放缓冲时间	Delay-on de-energisation	≤30ms	≤30ms
恢复时间	Recovery time	≤100ms	≤100ms
电源短时中断	Supply short interruption	20ms	20ms
环境特性	Environmental data		
电磁兼容	EMC	EN60947, EN61000-6-2, EN61000-6-4	EN60947, EN61000-6-2, EN61000-6-4
振动	Vibration	Vibration frequency: 10Hz~55Hz; Vibration amplitude: 0.35mm	Vibration frequency: 10Hz~55Hz; Vibration amplitude: 0.35mm
使用温度	Ambient temperature	-20°C~+60°C	-20°C~+60°C
储存温度	Storage temperature	-40°C~+85°C	-40°C~+85°C
相对湿度	Relative humidity	10%~90%	10%~90%
海拔高度	Elevation	≤2000m	≤2000m
绝缘特性	Insulation data		
过压等级	Overvoltage category	III	III
污染等级	Pollution degree	2	2
额定绝缘电压	Rated insulation voltage	250V AC	250V AC
额定冲击电压	Rated impulse voltage	6000V (1.2/50us)	6000V (1.2/50us)
绝缘强度	Dielectric strength	1500V AC, 1min	1500V AC, 1min
电气间隙和爬电距离	Clearance and creepage distance	In accordance with EN 60947-1	In accordance with EN 60947-1
认证	Certification		
安全完整性等级	Safety integrity level	SIL3	SIL3
性能等级	Performance level	PLe	PLe
安全类别	Category	Cat.4	Cat.4

外观图 Products show

114.5mm×99.0mm×22.5mm



功能框图 Block diagram

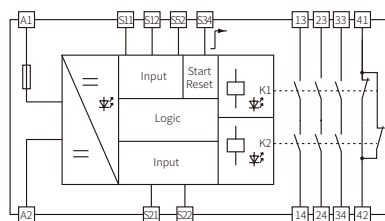

CZSR8001-3A1B-P

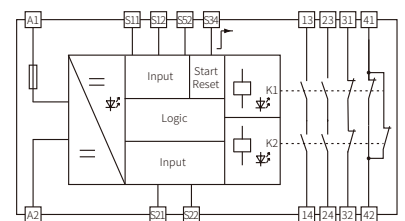

CZSR8101-3A1B-N



双手按钮输入 Two-Hand Control Buttons Input

产品特征 Features

双通道输入 Dual channel

符合EN 574 Type IIIC要求 Accord with EN 574 Type IIIC

CZSR8201-3A1B

电源特性	Power data	
供电电压	Supply voltage	24V DC/AC
电压容差	Voltage tolerance	0.85~1.1
电流损耗	Current consumption	≤60mA (24V DC) / ≤140mA (24V AC)
输入特性	Input data	
输入电流	Input current	≤50mA (24V DC)
导线电阻	Cable resistance	≤15Ω
输入设备	Input devices	Two-hand control buttons
输出特性	Output data	
触点数量	Number of contacts	3NO+1NC
触点材料	Contact material	AgSnO ₂ + 0.2 μm Au
触点熔丝保护	External contact fuse protection	10A gL/gG NEOZED (NO); 6A gL/gG NEOZED (NC)
触点机械寿命	Mechanical endurance of contacts	10 ⁷ 次以上
切换容量	Utilisation category	In accordance with EN60947-5-1: AC-15, 5A/230V; DC-13, 5A/24V
时间特性	Time data	
吸合缓冲时间	Switch-on delay	≤30ms
释放缓冲时间	Delay-on de-energisation	≤15ms
同步时间	Simultaneity	≤500ms
恢复时间	Recovery time	≤250ms
电源短时中断	Supply short interruption	20ms
环境特性	Environmental data	
电磁兼容	EMC	EN60947, EN61000-6-2, EN61000-6-4
振动	Vibration	Vibration frequency: 10Hz~55Hz; Vibration amplitude: 0.35mm
使用温度	Ambient temperature	-20°C~+60°C
储存温度	Storage temperature	-40°C~+85°C
相对湿度	Relative humidity	10%~90%
海拔高度	Elevation	≤2000m
绝缘特性	Insulation data	
过压等级	Overvoltage category	III
污染等级	Pollution degree	2
额定绝缘电压	Rated insulation voltage	250V AC
额定冲击电压	Rated impulse voltage	6000V (1.2/50us)
绝缘强度	Dielectric strength	1500V AC, 1min
电气间隙和爬电距离	Clearance and creepage distance	In accordance with EN 60947-1
认证	Certification	
安全完整性等级	Safety integrity level	SIL3
性能等级	Performance level	PLe
安全类别	Category	Cat.4

外观图 Products show

114.5mm×99.0mm×22.5mm



功能框图 Block diagram

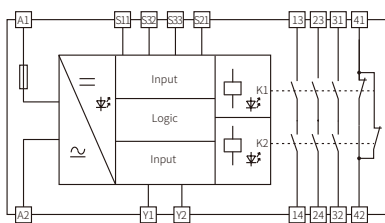

CZSR8201-3A1B



安全地毯输入 Safety Mats Input

产品特征 Features

支持四线制安全地毯输入 4-wire safety mats
支持受监控的手动复位 Monitored manual reset

CZSR8301-3A1B

CZSR8301-3A1B(M)

电源特性	Power data		
供电电压	Supply voltage	24V DC/AC	24V DC/AC
电压容差	Voltage tolerance	0.85~1.1	0.85~1.1
电流损耗	Current consumption	≤90mA (24V DC) / ≤240mA (24V AC)	≤90mA (24V DC) / ≤240mA (24V AC)
输入特性	Input data		
输入电流	Input current	≤50mA (24V DC)	≤50mA (24V DC)
导线电阻	Cable resistance	≤15Ω	≤15Ω
输入设备	Input devices	Safety mats (4-wire)	Safety mats (4-wire)
输出特性	Output data		
触点数量	Number of contacts	3NO+1NC	3NO+1NC
触点材料	Contact material	AgSnO ₂ + 0.2 μm Au	AgSnO ₂ + 0.2 μm Au
触点熔丝保护	External contact fuse protection	10A gL/gG NEOZED (NO); 6A gL/gG NEOZED (NC)	10A gL/gG NEOZED (NO); 6A gL/gG NEOZED (NC)
触点机械寿命	Mechanical endurance of contacts	10 ⁷ 次以上	10 ⁷ 次以上
切换容量	Utilisation category	In accordance with EN60947-5-1: AC-15, 5A/230V; DC-13, 5A/24V	In accordance with EN60947-5-1: AC-15, 5A/230V; DC-13, 5A/24V
时间特性	Time data		
吸合缓冲时间	Switch-on delay	≤300ms	≤150ms
释放缓冲时间	Delay-on de-energisation	≤30ms	≤30ms
恢复时间	Recovery time	≤300ms	≤300ms
电源短时中断	Supply short interruption	20ms	20ms
环境特性	Environmental data		
电磁兼容	EMC	EN60947, EN61000-6-2, EN61000-6-4	EN60947, EN61000-6-2, EN61000-6-4
振动	Vibration	Vibration frequency: 10Hz~55Hz; Vibration amplitude: 0.35mm	Vibration frequency: 10Hz~55Hz; Vibration amplitude: 0.35mm
使用温度	Ambient temperature	-20°C~+60°C	-20°C~+60°C
储存温度	Storage temperature	-40°C~+85°C	-40°C~+85°C
相对湿度	Relative humidity	10%~90%	10%~90%
海拔高度	Elevation	≤2000m	≤2000m
绝缘特性	Insulation data		
过压等级	Overvoltage category	III	III
污染等级	Pollution degree	2	2
额定绝缘电压	Rated insulation voltage	250V AC	250V AC
额定冲击电压	Rated impulse voltage	6000V (1.2/50us)	6000V (1.2/50us)
绝缘强度	Dielectric strength	1500V AC, 1min	1500V AC, 1min
电气间隙和爬电距离	Clearance and creepage distance	In accordance with EN 60947-1	In accordance with EN 60947-1
认证	Certification		
安全完整性等级	Safety integrity level	SIL3	SIL3
性能等级	Performance level	PLe	PLe
安全类别	Category	Cat.4	Cat.4

外观图 Products show

114.5mm×99.0mm×22.5mm



功能框图 Block diagram

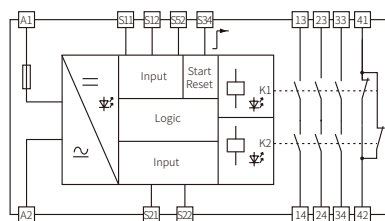

CZSR8301-3A1B

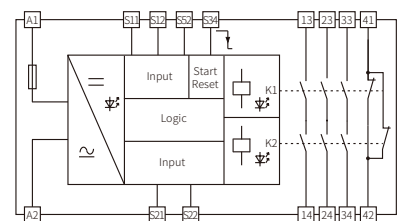

CZSR8301-3A1B(M)

产品特征 Features

支持二线制安全地毯/触边 2-wire safety mats/edges

支持自动复位 Automatic reset

支持受监控的手动复位 Monitored manual reset

CZSR8302-3A1B

CZSR8303-3A1B

电源特性	Power data		
供电电压	Supply voltage	24V DC/AC	100V~230V AC
电压容差	Voltage tolerance	0.85~1.1	-
电流损耗	Current consumption	≤95mA (24V DC) / ≤240mA (24V AC)	≤7 VA (220V AC)
输入特性	Input data		
输入电流	Input current	≤10mA (24V DC)	≤10mA (220V AC)
导线电阻	Cable resistance	≤15Ω	≤15Ω
输入设备	Input devices	Safety mats, safety edges (2-wire)	Safety mats, safety edges (2 or 4-wire)
终端电阻	Terminal resistance	1.0KΩ ~ 10KΩ	1.0KΩ ~ 10KΩ
输出特性	Output data		
触点数量	Number of contacts	3NO+1NC	3NO+1NC
触点材料	Contact material	AgSnO ₂ + 0.2 μm Au	AgSnO ₂ + 0.2 μm Au
触点熔丝保护	External contact fuse protection	10A gL/gG NEOZED (NO); 6A gL/gG NEOZED (NC)	10A gL/gG NEOZED (NO); 6A gL/gG NEOZED (NC)
触点机械寿命	Mechanical endurance of contacts	10 ⁷ 次以上	10 ⁷ 次以上
切换容量	Utilisation category	In accordance with EN60947-5-1: AC-15, 5A/230V; DC-13, 5A/24V	In accordance with EN60947-5-1: AC-15, 5A/230V; DC-13, 5A/24V
时间特性	Time data		
吸合缓冲时间	Switch-on delay	≤300ms	≤300ms
释放缓冲时间	Delay-on de-energisation	≤30ms	≤30ms
恢复时间	Recovery time	≤100ms	≤500ms
电源短时中断	Supply short interruption	20ms	20ms
环境特性	Environmental data		
电磁兼容	EMC	EN60947, EN61000-6-2, EN61000-6-4	EN60947, EN61000-6-2, EN61000-6-4
振动	Vibration	Vibration frequency: 10Hz~55Hz; Vibration amplitude: 0.35mm	Vibration frequency: 10Hz~55Hz; Vibration amplitude: 0.35mm
使用温度	Ambient temperature	-20°C~+60°C	-20°C~+60°C
储存温度	Storage temperature	-40°C~+85°C	-40°C~+85°C
相对湿度	Relative humidity	10%~90%	10%~90%
海拔高度	Elevation	≤2000m	≤2000m
绝缘特性	Insulation data		
过压等级	Overvoltage category	III	III
污染等级	Pollution degree	2	2
额定绝缘电压	Rated insulation voltage	250V AC	250V AC
额定冲击电压	Rated impulse voltage	6000V (1.2/50us)	6000V (1.2/50us)
绝缘强度	Dielectric strength	1500V AC, 1min	1500V AC, 1min
电气间隙和爬电距离	Clearance and creepage distance	In accordance with EN 60947-1	In accordance with EN 60947-1
认证	Certification		
安全完整性等级	Safety integrity level	SIL3	SIL3
性能等级	Performance level	PLe	PLe
安全类别	Category	Cat.4	Cat.4

外观图 Products show

114.5mm × 99.0mm × 22.5mm



功能框图 Block diagram

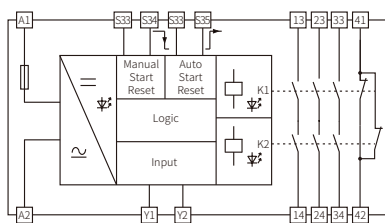

CZSR8302-3A1B

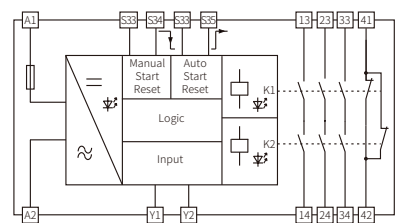

CZSR8303-3A1B

安全地毯输入 Safety Mats Input

Newly Released

产品特征 Features

支持二/四线制安全地毯/触边 2 or 4-wire safety mats/edges
支持自动复位 Automatic reset
支持受监控的手动复位 Monitored manual reset

CZSR8302-2A1B1S

CZSR8302-2AT1BT1S

电源特性	Power data		
供电电压	Supply voltage	24V DC/AC	24V DC/AC
电压容差	Voltage tolerance	0.85~1.1	0.85 ~ 1.1
电流损耗	Current consumption	≤120mA (24V DC), ≤300mA (24V AC)	≤120mA (24V DC), ≤300mA (24V AC)
输入特性	Input data		
输入电流	Input current	≤10mA (24V DC)	≤10mA (24V DC)
导线电阻	Cable resistance	≤15Ω	≤15Ω
输入设备	Input devices	Safety mats, safety edges (2 or 4-wire)	Safety switches, Contact switches
终端电阻	Terminal resistance	1.0KΩ ~ 10KΩ	1.0KΩ ~ 10KΩ
输出特性	Output data		
触点数量	Number of contacts	2NO+1NC+1SO	2NO(t)+1NC(t)
继电器触点材料	Contact material	AgSnO ₂ + 0.2 μm Au	AgSnO ₂ + 0.2 μm Au
继电器触点熔丝保护	External contact fuse protection	10A gL/gG NEOZED (NO); 6A gL/gG NEOZED (NC)	10A gL/gG NEOZED (N/O); 6A gL/gG NEOZED (N/C)
继电器触点机械寿命	Mechanical endurance of contacts	10 ⁷ 次以上	10 ⁷ 次以上
继电器切换容量	Utilisation category	In accordance with EN60947-5-1: AC-15, 5A/230V; DC-13, 5A/24V	In accordance with EN60947-5-1: AC-15, 5A/230V; DC-13, 5A/24V
半导体输出特征	Semiconductor output data	Number of semi-output: 1SO Driving ability: 20mA/24V DC	Number of semi-output: 1SO Driving ability: 20mA/24V DC
时间特性	Time data		
吸合缓冲时间	Switch-on delay	≤300ms	≤300ms
释放缓冲时间	Delay-on de-energisation	≤30ms(instantaneous)	≤30ms (instantaneous) 0s, 0.5s, 1s, 2s, 3s, 5s(Delated factory set as 5s)
恢复时间	Recovery time	≤100ms	≤100ms
电源短时中断	Supply short interruption	20ms	20ms
环境特性	Environmental data		
电磁兼容	EMC	EN60947, EN61000-6-2, EN61000-6-4	EN60947, EN61000-6-2, EN61000-6-4
振动	Vibration	Vibration frequency: 10Hz~55Hz; Vibration amplitude: 0.35mm	Vibration frequency: 10Hz~55Hz; Vibration amplitude: 0.35mm
使用温度	Ambient temperature	-20°C~+60°C	-20°C~+60°C
储存温度	Storage temperature	-40°C~+85°C	-40°C~+85°C
相对湿度	Relative humidity	10%~90%	10%~90%
海拔高度	Elevation	≤2000m	≤2000m
绝缘特性	Insulation data		
过压等级	Overvoltage category	III	III
污染等级	Pollution degree	2	2
额定绝缘电压	Rated insulation voltage	250V AC	250V AC
额定冲击电压	Rated impulse voltage	6000V (1.2/50us)	6000V (1.2/50us)
绝缘强度	Dielectric strength	1500V AC, 1min	1500V AC, 1min
电气间隙和爬电距离	Clearance and creepage distance	In accordance with EN 60947-1	In accordance with EN 60947-1
认证	Certification		
安全完整性等级	Safety integrity level	SIL3	SIL3
性能等级	Performance level	PLe	PLe
安全类别	Category	Cat.4	Cat.4

外观图 Products show

114.5mm × 99.0mm × 22.5mm



SIL3
IEC61508
PLe
Cat.4
EN15013849

功能框图 Block diagram

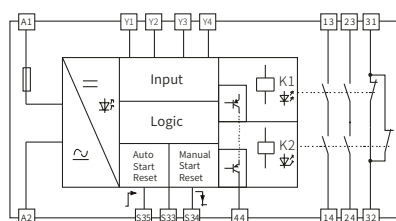

CZSR8302-2A1B1S

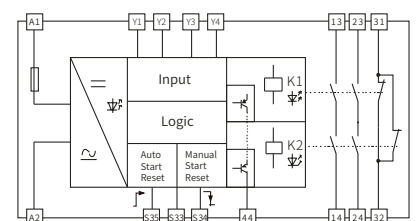

CZSR8302-2AT1BT1S

产品特征 Features

独立双通道 Separate two channels

故障诊断输出触点 Fault diagnosis contact

CZSR8801-4A2B

CZSR8801-8A4B

电源特性	Power data	
供电电压	Supply voltage	20V~30V DC
电流损耗	Current consumption	≤50mA (24V DC)
输入特性	Input data	
通道数	Number of channels	1
输入电流	Input current	≤50mA (24V DC)
导线电阻	Cable resistance	≤15Ω
输入设备	Input devices	Safety switches, Contact switches
继电器输出特性	Relay output data	
触点数量	Number of contacts	4NO+2NC
触点材料	Contact material	AgSnO ₂ + 0.2 μm Au
触点熔丝保护	External contact fuse protection	10A gL/gG NEOZED (NO); 6A gL/gG NEOZED (NC)
触点机械寿命	Mechanical endurance of contacts	10 ⁷ 次以上
切换容量	Utilisation category	In accordance with EN60947-5-1: AC-15, 5A/230V; DC-13, 5A/24V
时间特性	Time data	
吸合缓冲时间	Switch-on delay	≤30ms
释放缓冲时间	Delay-on de-energisation	≤20ms
恢复时间	Recovery time	≤100ms
电源短时中断	Supply short interruption	20ms
环境特性	Environmental data	
电磁兼容	EMC	EN60947, EN61000-6-2, EN61000-6-4
振动	Vibration	Vibration frequency: 10Hz~55Hz; Vibration amplitude: 0.35mm
使用温度	Ambient temperature	-20°C~+60°C
储存温度	Storage temperature	-40°C~+85°C
相对湿度	Relative humidity	10%~90%
海拔高度	Elevation	≤2000m
绝缘特性	Insulation data	
过压等级	Overvoltage category	III
污染等级	Pollution degree	2
额定绝缘电压	Rated insulation voltage	250V AC
额定冲击电压	Rated impulse voltage	6000V (1.2/50us)
绝缘强度	Dielectric strength	1500V AC, 1min
电气间隙和爬电距离	Clearance and creepage distance	In accordance with EN 60947-1
认证	Certification	
安全完整性等级	Safety integrity level	SIL3
性能等级	Performance level	PLe
安全类别	Category	Cat.4

外观图 Products show

114.5mm×99.0mm×22.5mm
114.5mm×99.0mm×45.0mm

CZSR8801-4A2B
CZSR8801-8A4B



功能框图 Block diagram

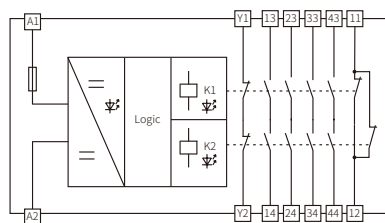

CZSR8801-4A2B

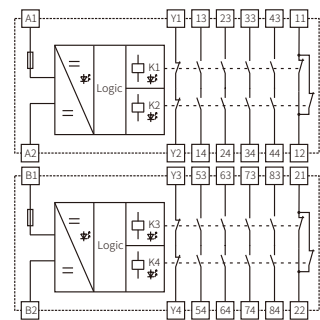

CZSR8801-8A4B



接线示意 Wiring Diagram

CZSR8001-3A1B的接线示意（急停按钮）

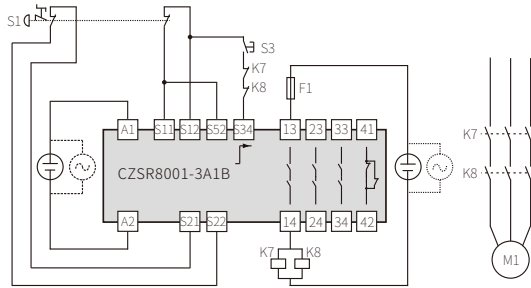

- 双通道急停按钮输入 Dual channel E-stop buttons input
- 通道间短路监控 Short circuit monitoring
- 手动复位 Manual reset
- 带输出触点反馈 Output with EDM
- 适用于最高安全等级4 Up to Cat.4

CZSR8001-3A1B的接线示意（安全门）

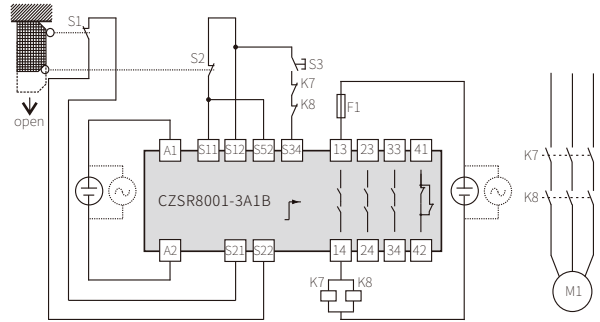

- 双通道安全门输入 Dual channel safety gates input
- 通道间短路监控 Short circuit monitoring
- 手动复位 Manual reset
- 带输出触点反馈 Output with EDM
- 适用于最高安全等级4 Up to Cat.4

CZSR8001-2A1B的接线示意（急停按钮）

Newly released

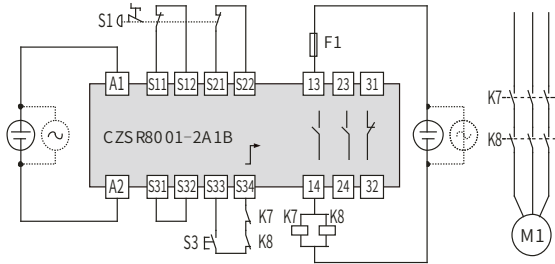

- 双通道急停按钮输入 Dual channel E-stop buttons input
- 通道间短路监控 Short circuit monitoring
- 手动复位 Manual reset
- 带输出触点反馈 Output with EDM
- 适用于最高安全等级4 Up to Cat.4

CZSR8001-2A1B3AT1BT的接线示意（急停按钮）

Newly released

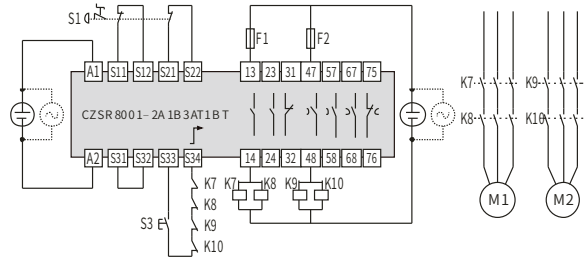

- 双通道急停按钮输入 Dual channel E-stop buttons input
- 通道间短路监控 Short circuit monitoring
- 手动复位 Manual reset
- 4路延时触点 4 delay-on contact
- 带输出触点反馈 Output with EDM
- 适用于最高安全等级4 Up to Cat.4

CZSR8001-3A1B-P的接线示意（PNP型安全光幕）

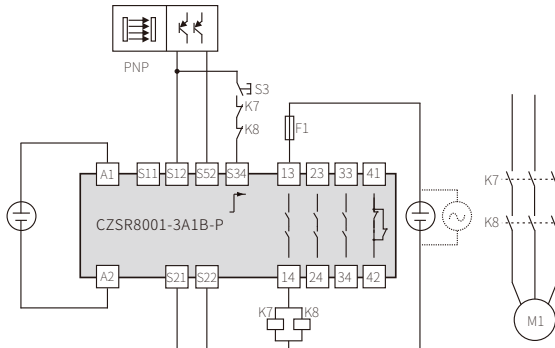

- 双通道PNP型安全光幕输入 Dual channel PNP type light beam devices input
- 手动复位 Manual reset
- 带输出触点反馈 Output with EDM
- 适用于最高安全等级4 Up to Cat.4

CZSR8101-3A1B-N的接线示意（NPN型安全光幕）

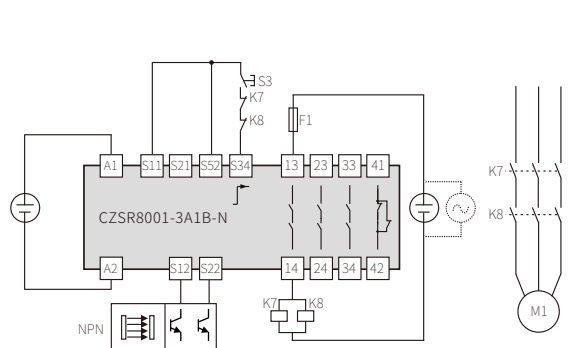

- 双通道NPN型安全光幕输入 Dual channel NPN type light beam devices input
- 手动复位 Manual reset
- 带输出触点反馈 Output with EDM
- 适用于最高安全等级4 Up to Cat.4

CZSR8201-3A1B的接线示意（双手按钮）

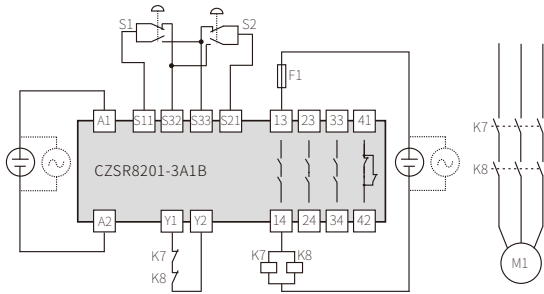

- 双手按钮输入 Two-hand control buttons input
- 符合EN574 TypeIIIC要求 In accord with EN574 type III C
- 带输出触点反馈 Output with EDM
- 适用于最高安全等级4 Up to Cat.4

CZSR8301-3A1B(M)的接线示意（四线制安全地毯）

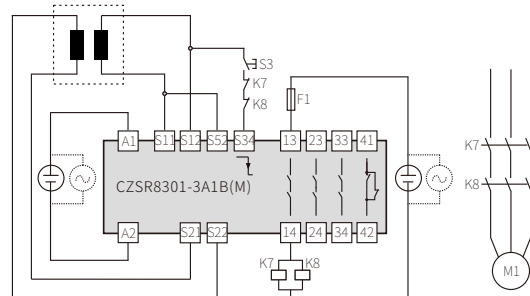

- 四线制安全地毯输入 4-wire safety mats input
- 受监控的手动复位 Monitored manual reset
- 带输出触点反馈 Output with EDM
- 适用于最高安全等级4 Up to Cat.4

CZSR8302-3A1B的接线示意（两线制安全地毯）

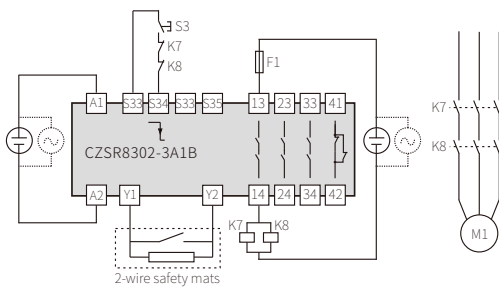

- 两线制安全地毯输入 2-wire safety mats input
- 受监控的手动复位 Monitored manual reset
- 带输出触点反馈 Output with EDM
- 适用于最高安全等级4 Up to Cat.4

CZSR8801-4A2B的接线示意（输出扩展）

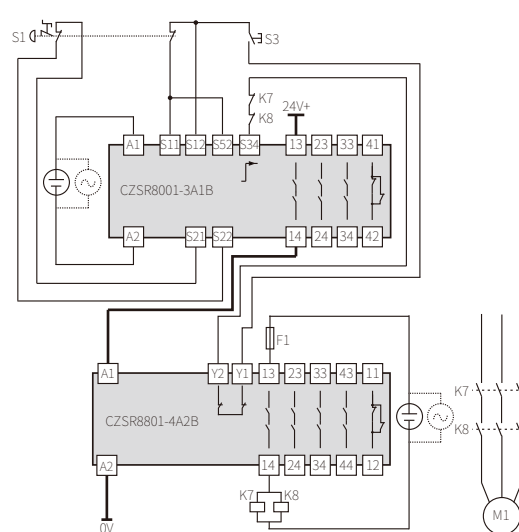

- 输出扩展(以CZSR8001-3A1B为主模块) Output extension (CZSR8001-3A1B used as main controller)
- 手动复位 Manual reset
- 带输出触点反馈 Output with EDM
- 适用于最高安全等级4 Up to Cat.4

CZSR8302-2A1B1S的接线示意（两线制安全触边）

Newly released

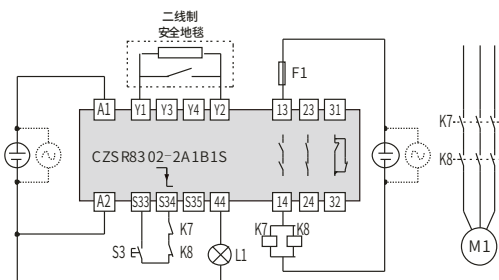

- 两线制安全触边输入 2-wire safety mats input
- 手动复位(复位按钮监控) Monitored manual reset
- 带输出触点反馈 Output with EDM
- 适用于最高安全等级4 Up to Cat.4
- 1路半导体辅助输出触点 1 delay-on auxiliary output ctnct of semiconductor

S3:复位按钮 Reset buttons
K7,K8,K9,K10:接触器 Contactors
F1,F2:外部保护熔丝 External protective fuse
M1,M2:电机 Motor

典型应用 Typical Application

应用一：注塑机

Wiring diagram 1 : Injection Moulding Machine

接线示意

Wiring Instructions

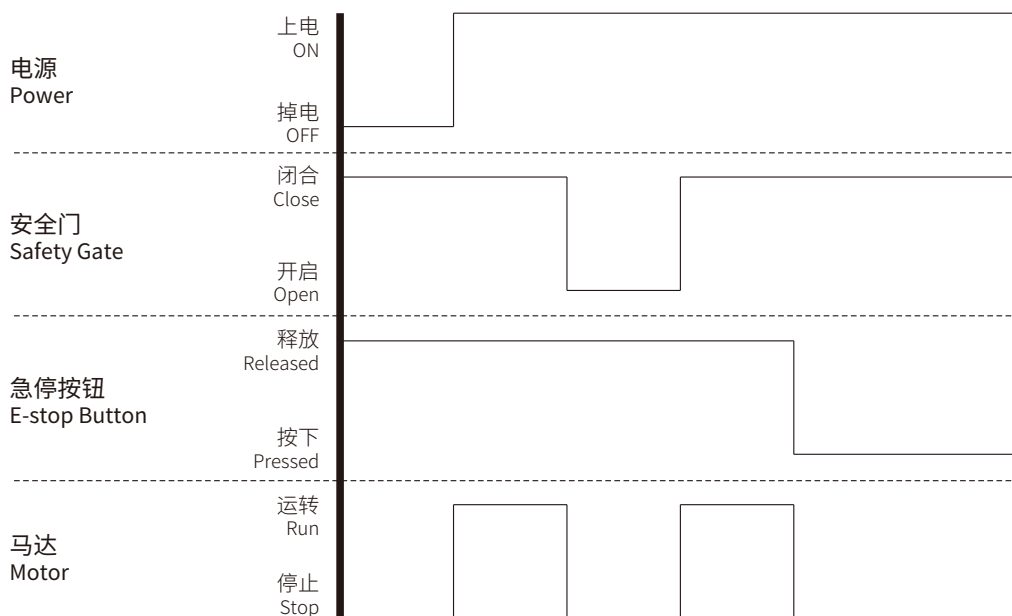
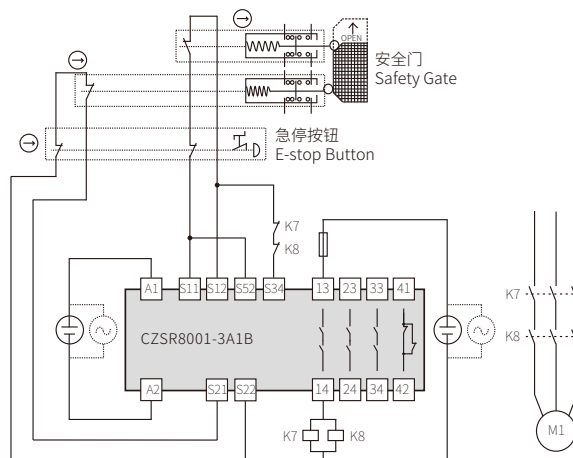
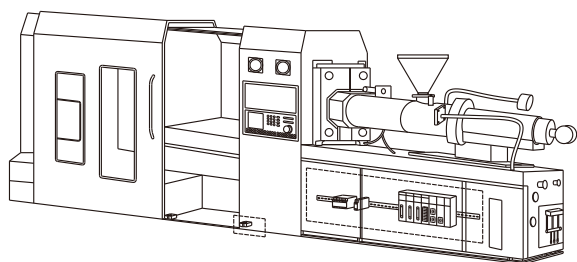

注塑机械安全控制系统一般由安全门、急停按钮、安全继电器等设备构成。危险主要来自于合模的挤压动作，通过安全门隔离操作人员与危险区域，当安全门闭合时，合模动作开启（马达运转），当安全门开启时，合模动作停止（马达停止）。

应用二：冲床

Application II : Punch Machine

接线示意

Wiring Instructions

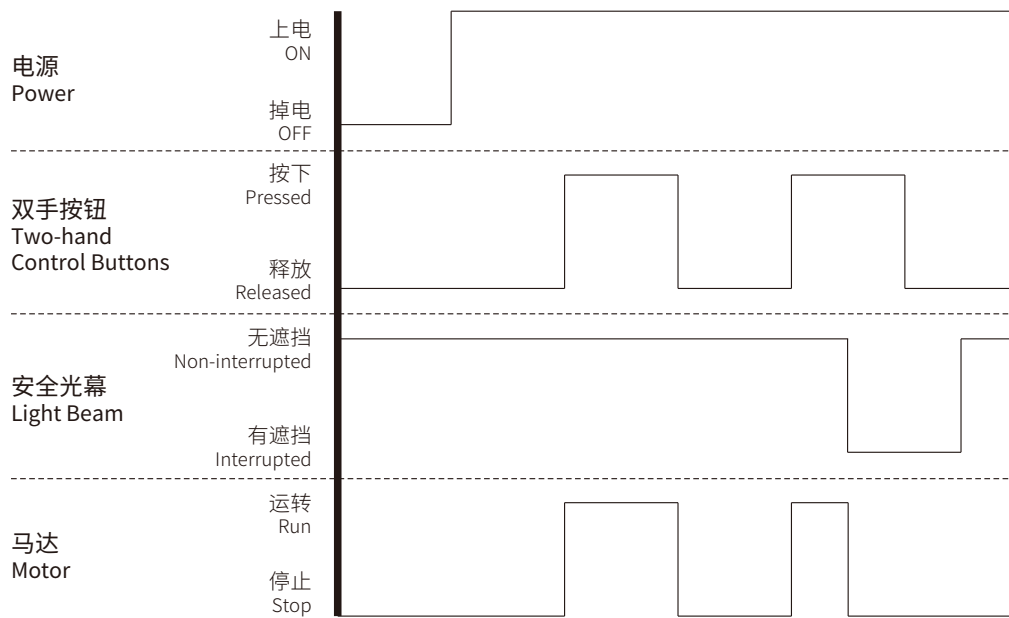
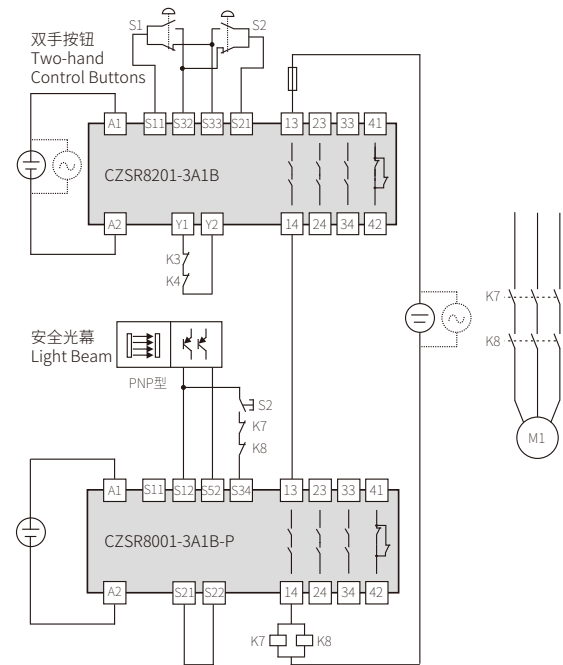
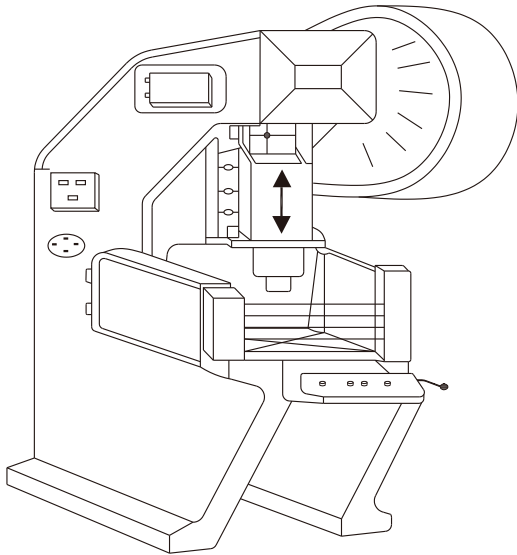

冲床机械安全控制系统一般由双手按钮、安全光幕、安全继电器构成。危险主要来自于冲击危险，操作人员需通过双手操作才能启动冲压操作（马达运转），并通过安全光幕使得操作人员肢体进入冲床工作区域时，机器停止冲压工作（马达停止）。



隔离式安全栅



信号隔离器



电涌保护器



安全继电器



智能 I/O



温度变送器

上海辰竹仪表有限公司

SHANGHAI CHENZHU INSTRUMENT CO.,LTD.

地址:上海市民益路201号漕河泾开发区松江新兴产业园区6号楼

Add:Building 6,201 Minyi Rd.,Shanghai 201612,P.R.China

电话/Tel:+86-21-64360668

网址/Web:www.chenzhu-inst.com

邮箱/Mail:chenzhu@chenzhu-inst.com